

enum.at
net.communications

The Generic Gateway

an ENUM driven PSTN-IP gateway

DI Dr. Klaus Darilion
klaus.darilion@enum.at

The Generic Gateway Concept

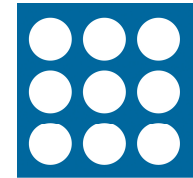

enum.at
net.communications

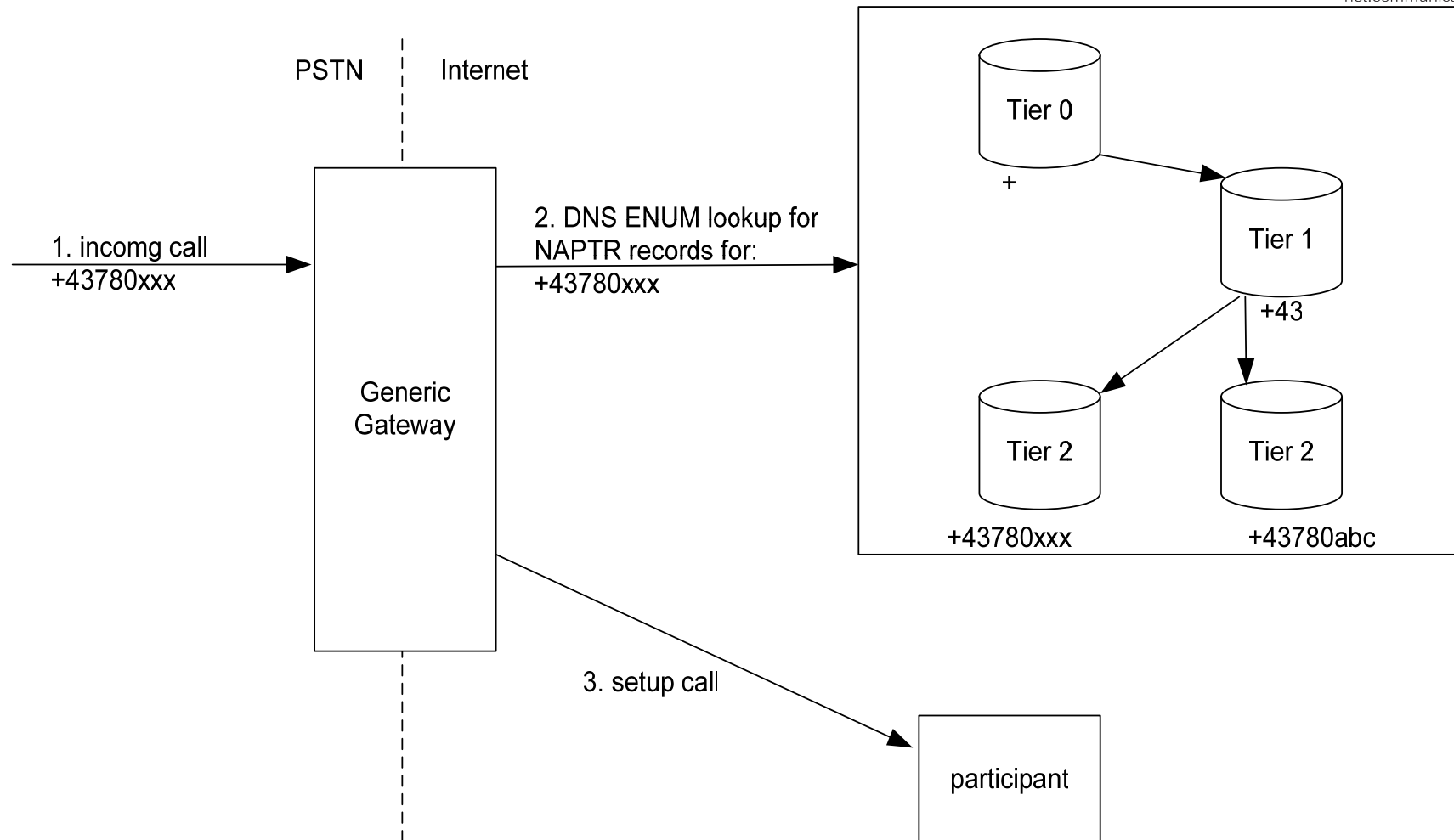

„Generic“

- various protocols
 - SIP
 - H.323
 - SMTP
- various services
 - voice
 - fax
- arbitrary number-blocks
 - 0780
 - 0720
 - 05xxx ...

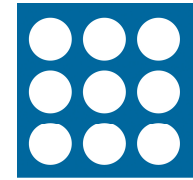

enum.at
net.communications

Physical Interfaces

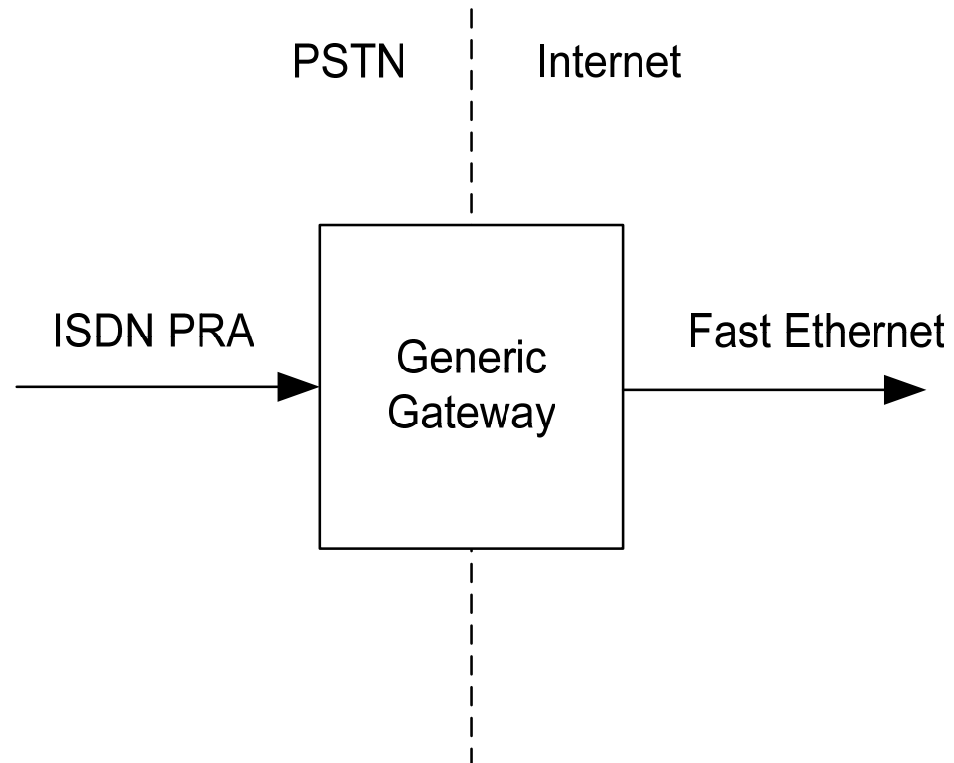

Logical Interfaces / Protocols

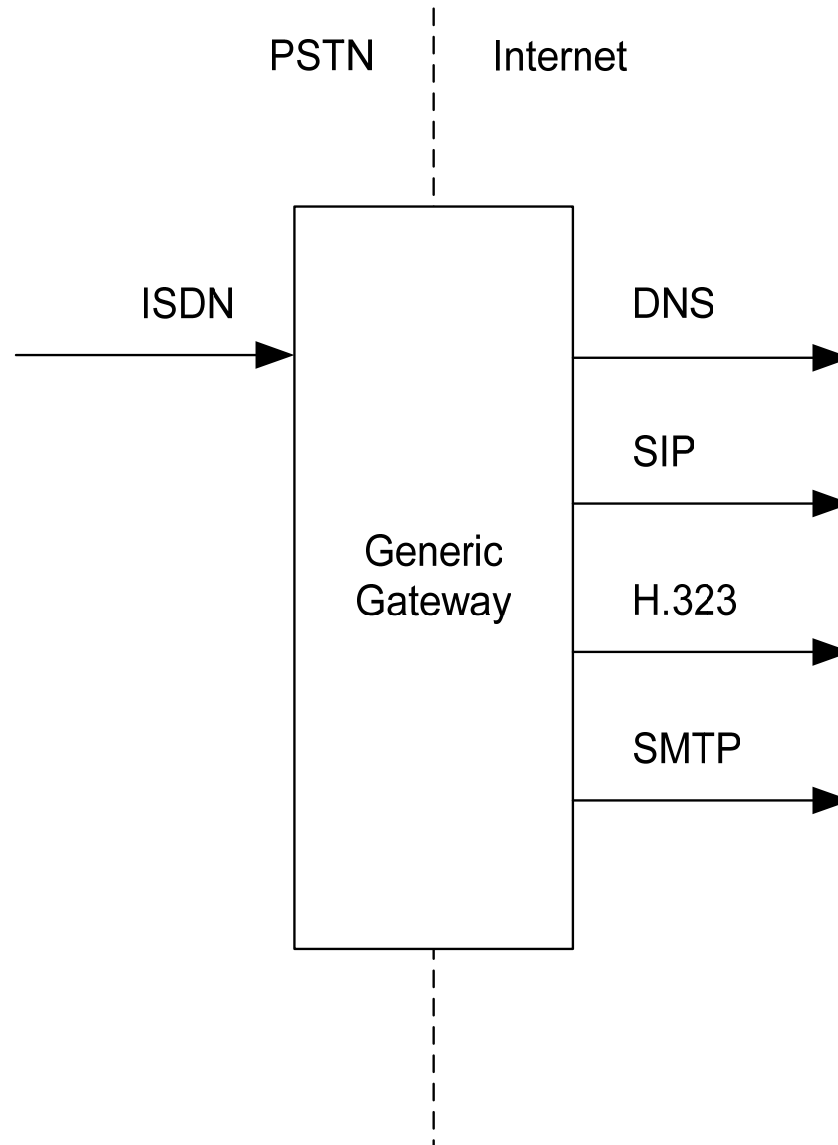

Generic Gateway Architecture

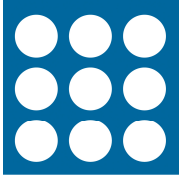

enum.at
net.communications

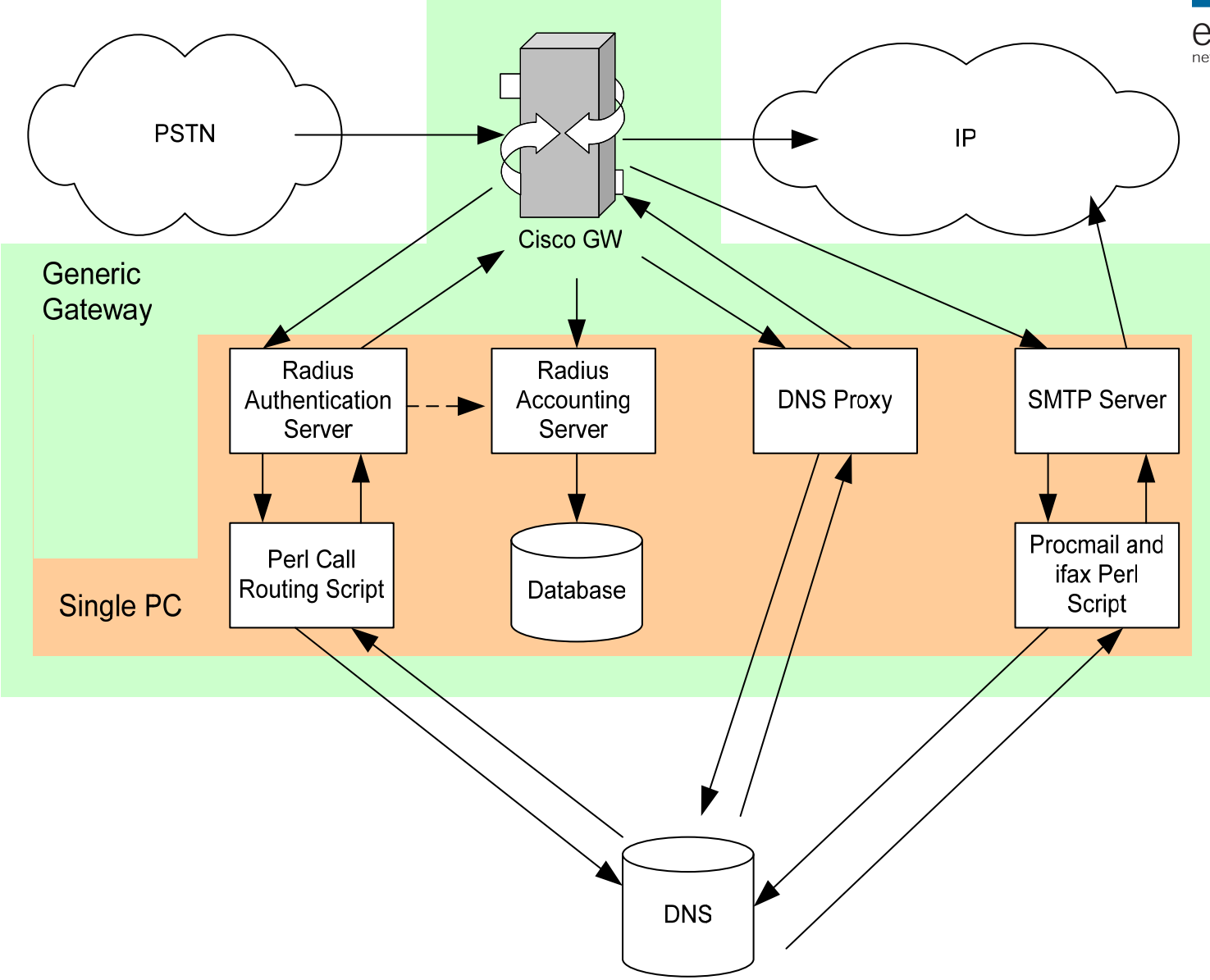

Hardware/Software Cisco GW

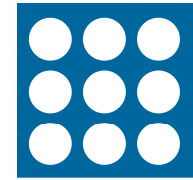

enum.at
net.communications

- at least one PRA interface and one Fast Ethernet interface
- at least one voice feature card (vfc) module installed (DSPs for VoIP).
- Cisco IOS version
 - IOS (tm) 5300 Software (C5300-JS-M), Version 12.2(13)T3, RELEASE SOFTWARE (fc2)
- Fax onramp application
 - fax_on_vfc_onramp_ap

Hardware/Software Helper PC

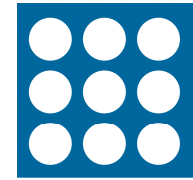

enum.at
net.communications

- Standard x86 compatible server hardware
- Operating system: Debian woody 3.0r2 Linux
- Radiator (or any other radius server which supports execution of perl scripts and database accounting)
- Perl (included in Debian distribution)
- Perl enum.pm module
<http://jprs.co.jp/enum/software/ENUM.pm>
- postgresql database (for storing accounting data, included in Debian)
- exim SMTP server (for delivery of fax emails, included in Debian)
- procmail (for email handling, included in Debian)
- dnsproxy to rewrite “old-style” NAPTRs.
- tftpd server (included in Debian)